

BIM LIVE Experience

Mechelen

Leading in MEP design

Stabiplan 
A TRIMBLE COMPANY





Programma

Sessie 1: Van BIM naar Constructible

14.00 uur: Ontvangst en welkomstwoord

14.30 uur: Constructible Models and Workflows

15.15 uur: Content-enabled

15.45 uur: koffiepauze

16.15 uur: Connected (BIM to Field)

17.00 uur: BIM in theorie - Bart Ingelaere, Dep. General Director WTCB

17.30 uur: BIM in de praktijk - Stijn en Marijn Pacquet, zaakvoerders Pacquet

17.50 uur: Vragenrondje

18.00 uur: Netwerkdruk en broodjes

Sessie 2: Stabicad LT

18.30 - 20.00 uur: Live demonstratie Stabicad LT (Electrical) en (Mechanical)

20.00 - 20.30 uur: Afsluitende drink



Stabiplan

A TRIMBLE COMPANY

-  +200 medewerkers
-  10.000 gebruikers
-  jaarlijks 200+ nieuwe klanten
-  Revit & AutoCAD
-  software & data
-  kantoren in 5 landen





Missie

Wij helpen onze klanten
betere gebouwinstallaties
te realiseren.

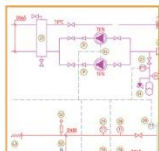
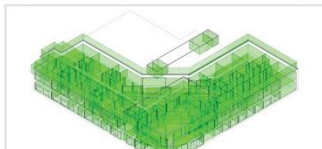
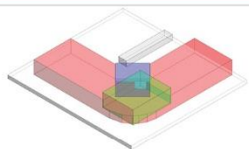

Elementcodeeditor

Elementcode	Categorie	Fabrikant	Levenscyclus	Type	Opmerkingen	G776	GLT/Nabestand	Fabr. art. nr.
1401	Akkumul	Bru	Bru	B0-002			284807317366	
1402	Accu	Bru	Bru	0000000000000000			12120021000000	
1403	Pomp	Wilo	Wilo	0000000000000000			45454042427058	0712423510424
1404	Motor							4184031

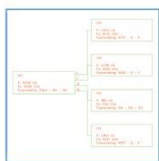
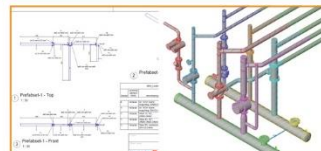
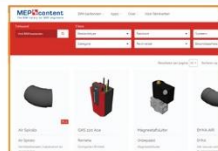

Bereken Installatie

Instalatie	1	2	3	4	5	6	7	8	9	10	11	12	13
1401	1	1	1	1	1	1	1	1	1	1	1	1	1
1402	1	1	1	1	1	1	1	1	1	1	1	1	1
1403	1	1	1	1	1	1	1	1	1	1	1	1	1
1404	1	1	1	1	1	1	1	1	1	1	1	1	1

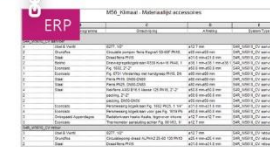
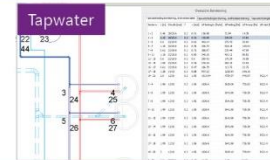
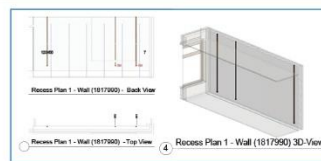
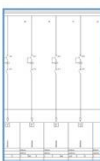

Lifecycle

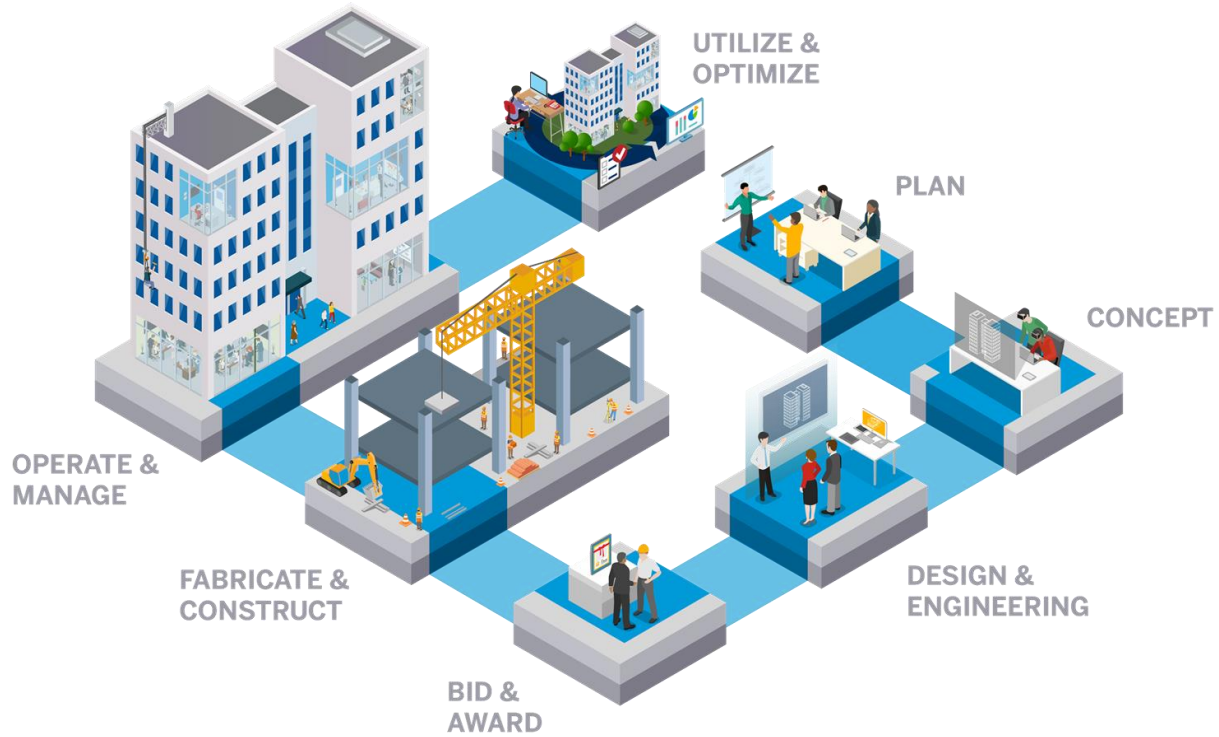

Investeer nu in BIM



Wij helpen u beter(e) gebouwinstallaties te ontwerpen, realiseren en beheren.

Win the Work

- Estimating
- Pricing Services
- Graphical Takeoff



Do the Work - Design

- Design
- Detailing
- Fabrication
- 3D Modeling
- BIM Collaboration
- Modeling Services

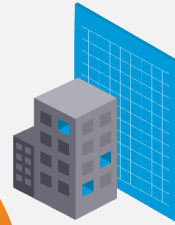

Stabicad
Apps
MEPcontent
Trimble Field
Solutions

Manage the Work

- Project Management
- Submittal Management
- Asset Tracking
- Testing & Verification



Do the Work - Build

- Layout Solutions
- 3D Laser Scanning
- Scanning Services
- Field Mobility



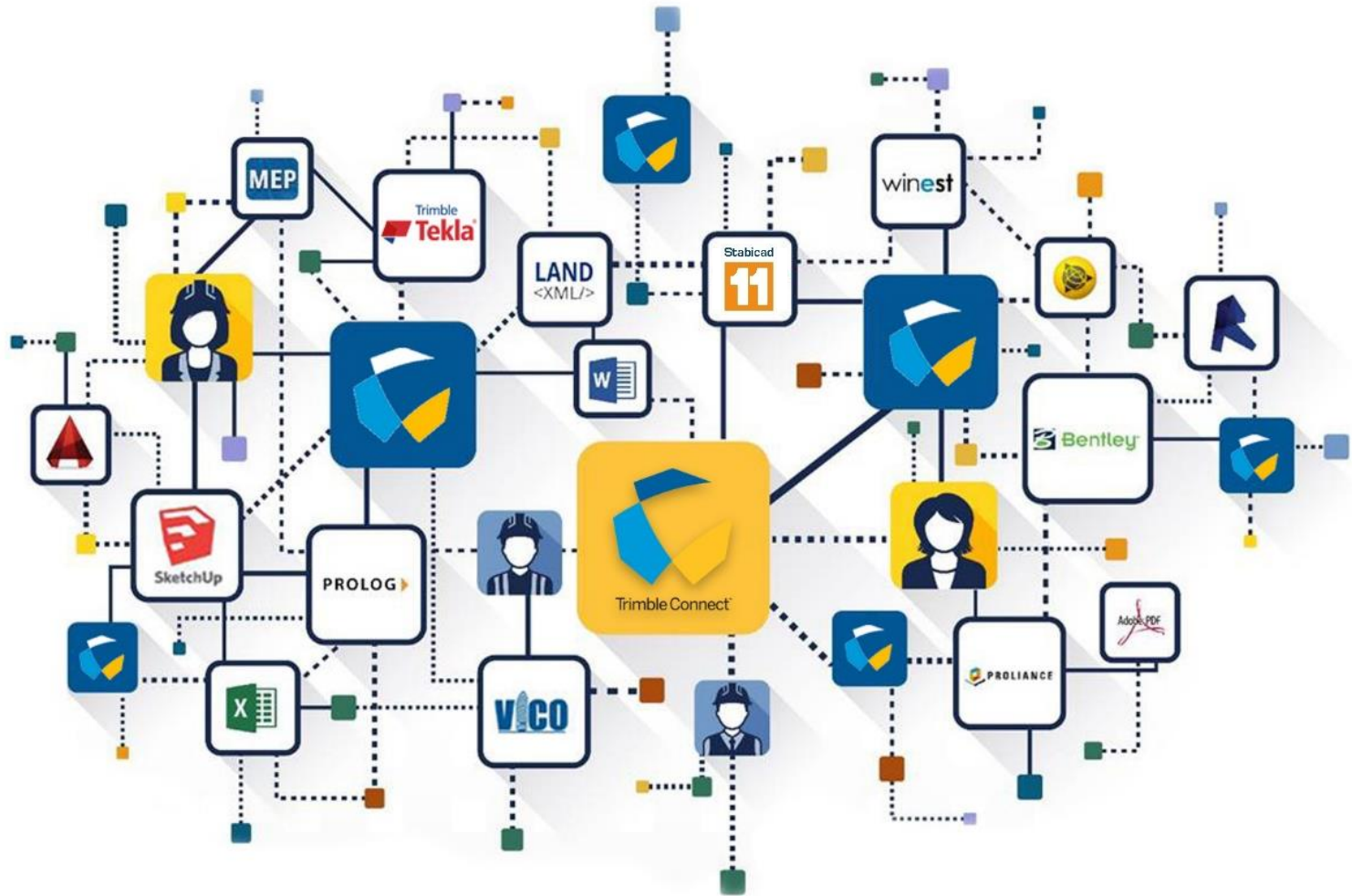

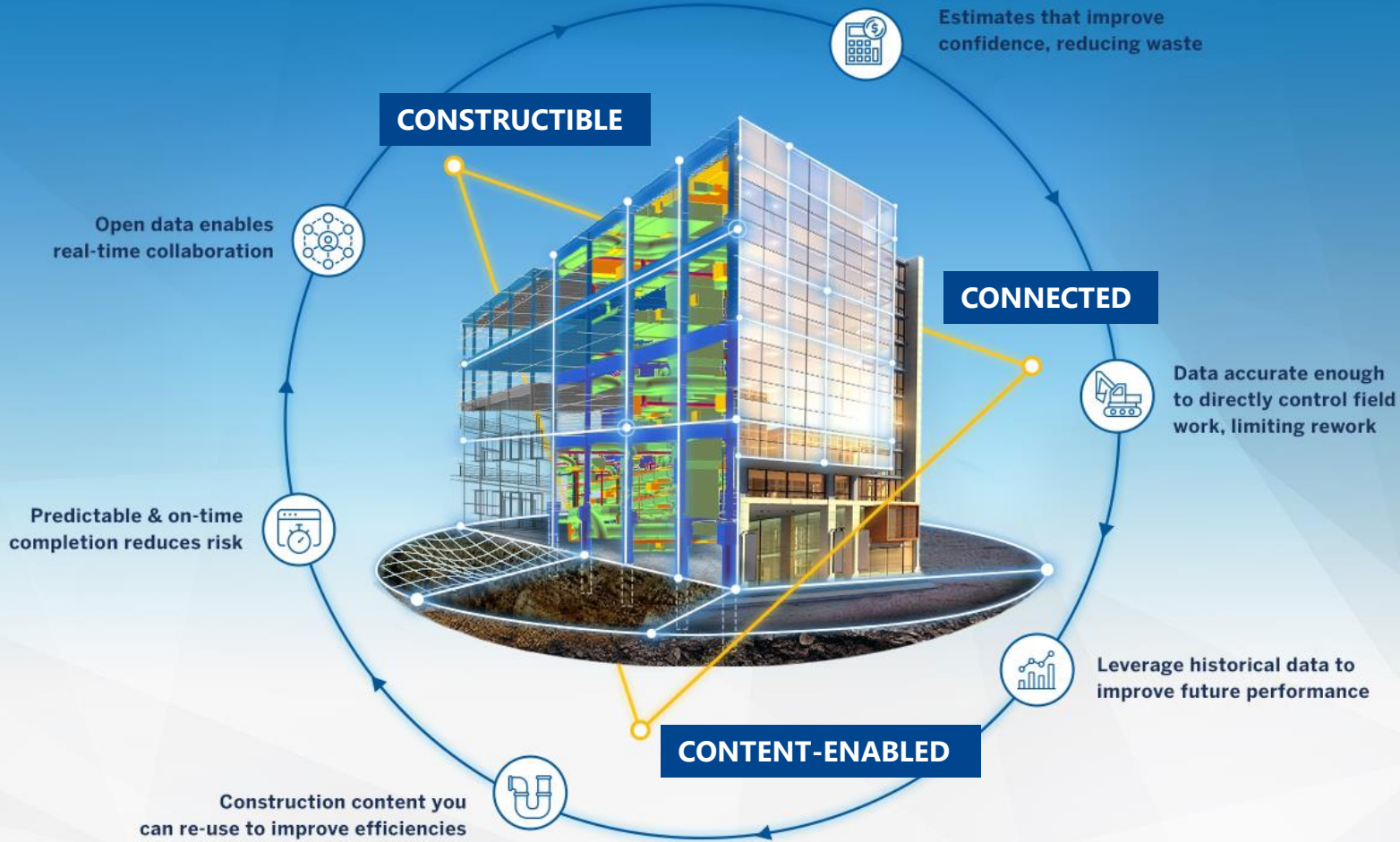

Mitsubishi Electric System Designer



MEPcontent Mitsubishi Electric System Designer

Search products
controller

Filter products
Series: City Multi
Category: BC Controller

Nominal Heating Capacity: kW
Nominal Cooling Capacity: kW
Sound Pressure Level: db(A)
Cooling EER: kW/kW
Heating COP: kW/kW

Export products in drawing
For New Design Tool: Export .xml
For SAP/CRM: Export .csv

Available products

- City Multi BC Controllers
Series: City Multi
Category: BC Controller
Article number: CMB-P1016V-KA
- City Multi BC Controllers**
Series: City Multi
Category: BC Controller
Article number: CMB-P104V-G1
- City Multi BC Controllers
Series: City Multi
Category: BC Controller
Article number: CMB-P104V-GB1
- City Multi BC Controllers
Series: City Multi
Category: BC Controller
Article number: CMB-P104V-J
- City Multi BC Controllers
Series: City Multi
Category: BC Controller
Article number: CMB-P104V-KR

1 - 22 / 22

Selected product

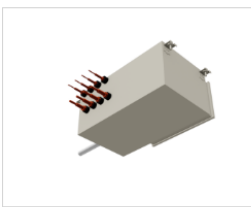

Series: City Multi
Category: BC Controller
Article number: CMB-P104V-G1
Cooling Source:
Nominal Cooling Capacity: 0 kW
Nominal Heating Capacity: 0 kW
Cooling EER: 0 kW/kW
Heating COP: 0 kW/kW
Sound Pressure Level: 0 db(A)

Place Cancel

MITSUBISHI ELECTRIC powered by MEPcontent

Search products



Filter products

Clear

Series

Select...



Category

Select...



Nominal Heating Capacity

kW

Nominal Cooling Capacity

kW

Sound Pressure Level

db(A)

Cooling EER

kW/kW

Heating COP

kW/kW

Export products in drawing

For New Design Tool

Export .xml

For SAP/CRM

Export .csv

Available products



City Multi BC Controllers

Series: City Multi
Category: BC Controller
Article number: CMB-P1010V-GA1



City Multi BC Controllers

Series: City Multi
Category: BC Controller
Article number: CMB-P1012V-J



City Multi BC Controllers

Series: City Multi
Category: BC Controller
Article number: CMB-P1012V-JA



City Multi BC Controllers

Series: City Multi
Category: BC Controller
Article number: CMB-P1013V-GA1



City Multi BC Controllers

Series: City Multi
Category: BC Controller
Article number: CMB-P1016V-GA1

Selected product

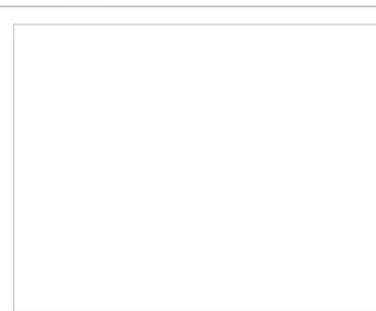

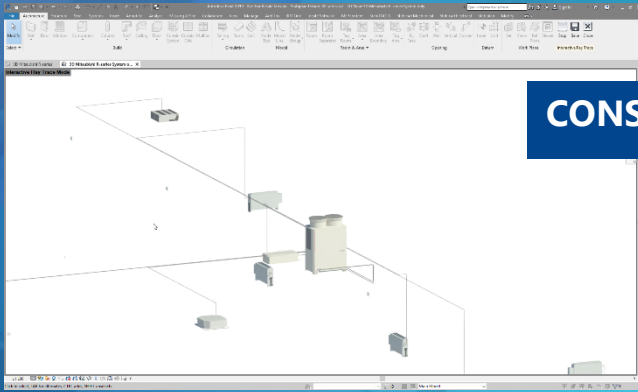

CONSTRUCTIBLE



CONNECTED

MEPcontent Mitsubishi Electric System Designer

Amount	Piping system	Description
1	CMB-P10BV-GA1	BC controllers
3	PAR-31MAA	Remote controller
1	PAR-CTD1MAA-DB	Remote controller
		Remote controller
		Depended indoor unit
		Sealed ducted indoor unit
		Non-sealed concealed indoor unit
		Wall mounted indoor unit
1	PLFY-P231BM-E	4-way blow ceiling cassette indoor unit
1	PURY-P350YN-A	Dry chiller outdoor unit

Amount	Piping system	Category	Manufacturer
8			
10	Other 1	S4R_Copper - Refrigerant pipes_Copper	Mitsubishi Refrigerant pipes
8	Other 1	Circular Bend	Mitsubishi Refrigerant pipes
6	Other 10	Circular Bend	Mitsubishi Refrigerant pipes
7	Other 10	S4R_Copper - Refrigerant pipes_Copper	Mitsubishi Refrigerant pipes
6	Other 11	Circular Bend	Mitsubishi Refrigerant pipes
7	Other 11	S4R_Copper - Refrigerant pipes_Copper	Mitsubishi Refrigerant pipes
6	Other 12	S4R_Copper - Refrigerant pipes_Copper	Mitsubishi Refrigerant pipes
5	Other 12	Circular Bend	Mitsubishi Refrigerant pipes
3	Other 15	Circular Bend	Mitsubishi Refrigerant pipes
3	Other 15	S4R_Copper - Refrigerant pipes_Copper	Mitsubishi Refrigerant pipes



CONTENT-ENABLED

MEPcontent Mitsubishi Electric System Designer

Search products

controller

Filter products

Series: City Multi

Category: BC Controller

Nominal Heating Capacity: 0kW

Nominal Cooling Capacity: 0kW

Sound Pressure Level: 0db(A)

Cooling EER: 0kW/W

Heating COP: 0kW/W

Export products in drawing

For New Design Tool: [Export cad](#)

For SAPICRM: [Export csw](#)

Available products

- City Multi BC Controllers
Series: City Multi
Category: BC Controller
Article number: CMB-P10BV-KA
- City Multi BC Controllers
Series: City Multi
Category: BC Controller
Article number: CMB-P10AV-G1
- City Multi BC Controllers
Series: City Multi
Category: BC Controller
Article number: CMB-P10AV-GB1
- City Multi BC Controllers
Series: City Multi
Category: BC Controller
Article number: CMB-P10AV-J
- City Multi BC Controllers
Series: City Multi
Category: BC Controller
Article number: CMB-P10AV-KE



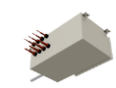



Selected product



Series: City Multi
Category: BC Controller
Article number: CMB-P10AV-G1
Cooling Source:
Nominal Cooling Capacity: 0 kW
Nominal Heating Capacity: 0 kW
Cooling EER: 0 kW/W
Heating COP: 0 kW/W
Sound Pressure Level: 0 db(A)

MITSUBISHI ELECTRIC powered by MEPcontent



 <p>ABB Switch Range Configurator</p>	 <p>Henco Product Line Placer</p>	 <p>POLOPLAST Product Line Placer</p>
 <p>Ostendorf Product Line Placer</p>	 <p>SANHA Product Line Placer</p>	 <p>Rexel Wholesaler Connector</p>

Producten

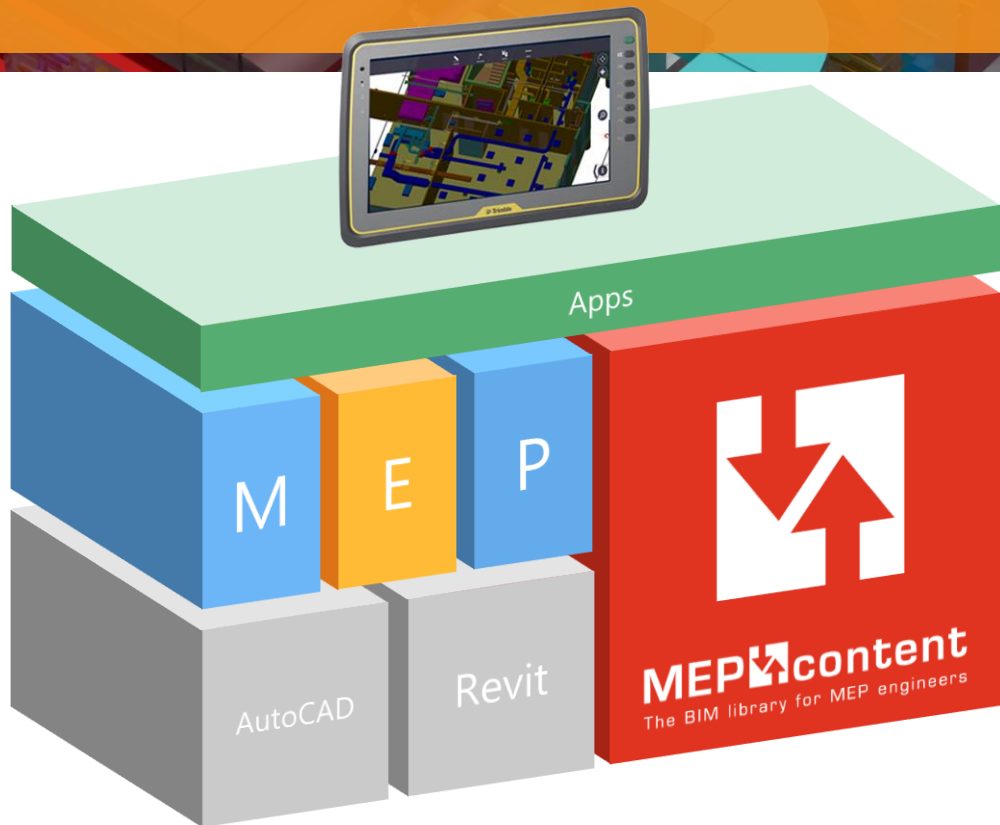

Producten



Stabicad

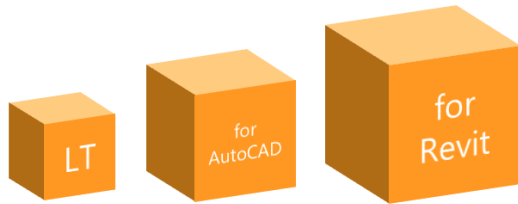

www.stabiplan.nl/stabicad

Bundle
S4A + S4R



MEP APPS FOR REVIT



store.mepcontent.com

MEPcontent Subscription

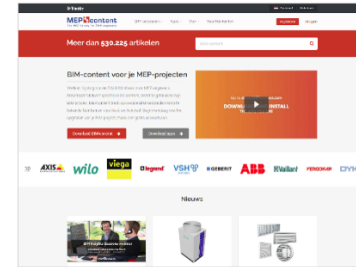

mepcontent.com

Leading in MEP design



E-installatietechniek

- Plaatsen symbolen
- Wandgoten
- Eendraadschema in Revit
- Domotica en coderen
- Wanduitslagen
- (Pilot) Kabelberekening NL
- Sparingen workflow
- Cloud/Trimble Connect

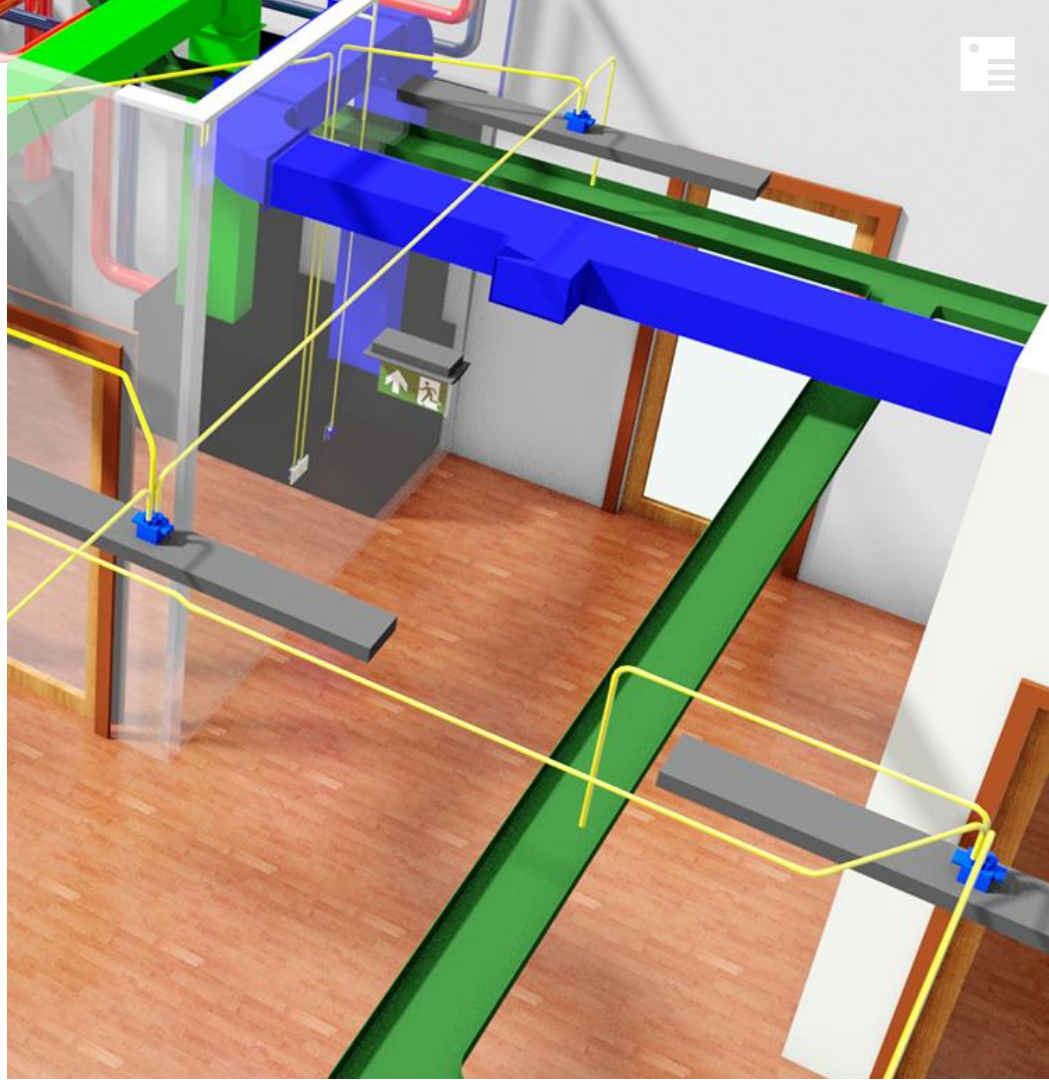

Prefab

1 Prefabset-1 - Top
1:33

2 Prefabset-1 - Isometric

Aantal	Levertijd sprong maas	MMS_uitgevoerd	Materiaaltype	helpstukken	Afmetingen
6	Viciale	SE 10/11 stans	CG120109000004		ø60 mm x 60 mm
1	Viciale	SE 10/11 stans	CG120109000004		ø120 mm x 120 mm
1	Viciale	Staple 15 100°	F0013004000004		ø60 mm x ø60 mm
1	Viciale	Staple 25 100°	F0020009000001		ø60 mm x ø60 mm x ø60 mm
1	Viciale	Staple 32 conisch	F00008130000007		ø120 mm x ø60 mm

3 Prefabset-1 - Front
1:33

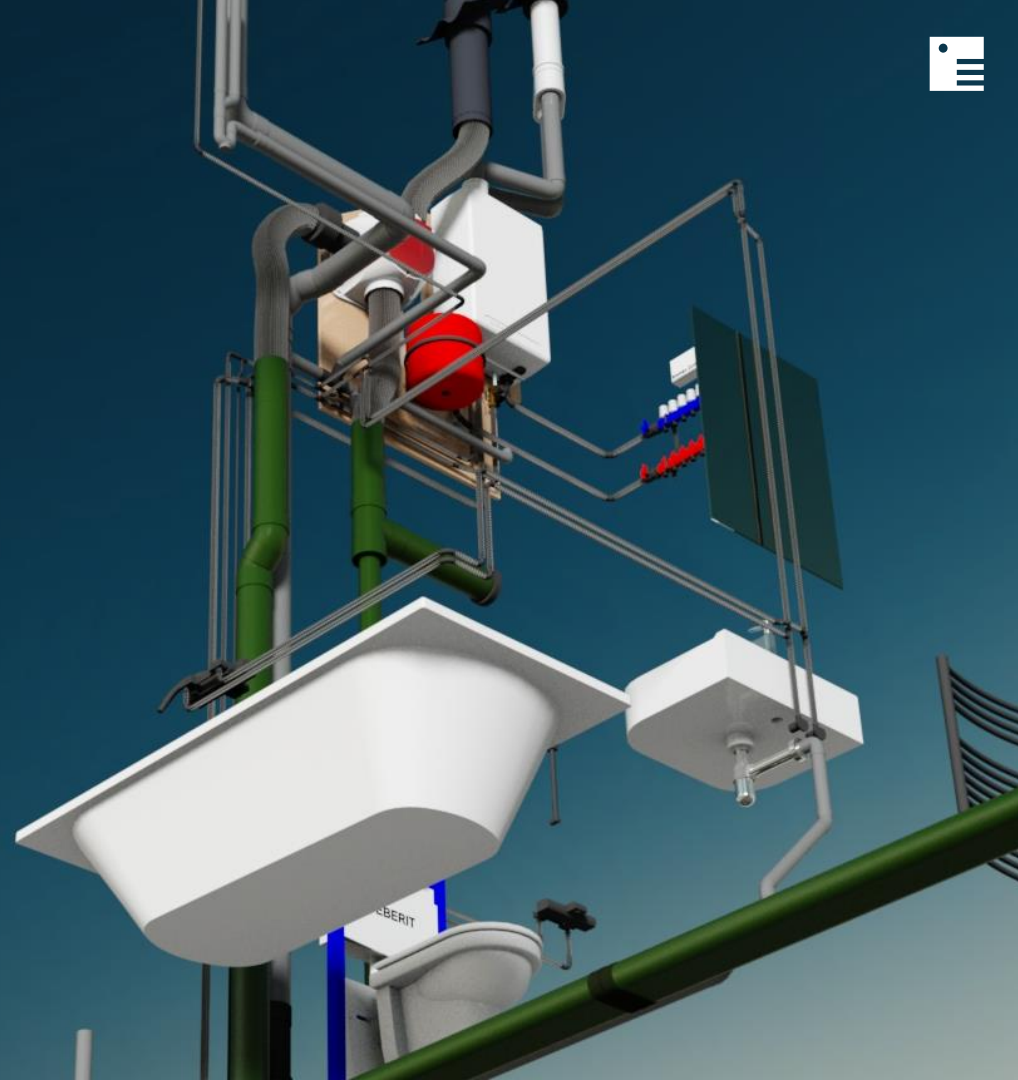
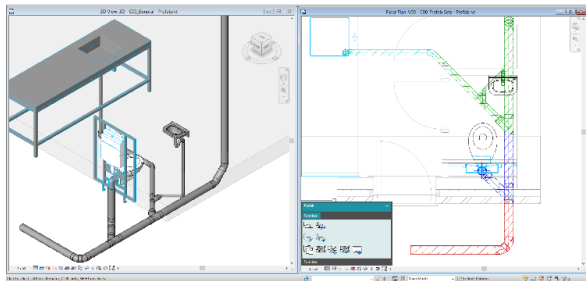

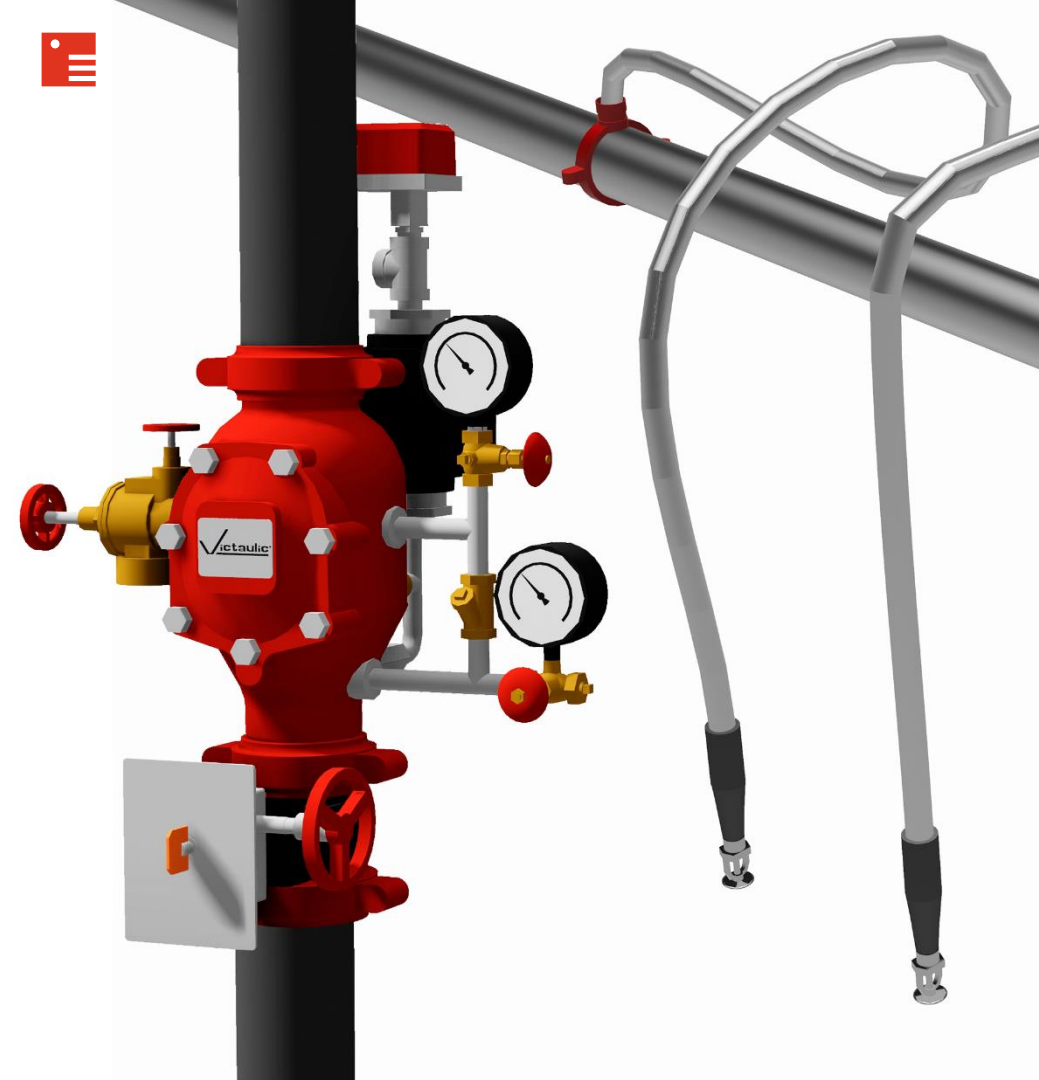

Sprinkler

Selecteren sprinklerset

Vrijgven begraaf
Type leiding: Staal Gegroefd Bus of kanaal Gegroefd DN80, Hoogte vanaf vloer: 0,00

Type sprinklerkop
Selecteren
Orbepaald Sprinkler Sprinklerkop Hangend net 1,2", Hoogte vanaf vloer: 0,00

Type hubstuk
Selecteren
Orbepaald Sprinkler Zedistruk Outlet koppeling 1"

Type verbinding
Selecteren
Orbepaald Sprinkler Bus of kanaal Flexibele slang 5/8" In 1"
Orbepaald Sprinkler Flexibele verbinding 1" 1/2" 1" - 1/2"

Type aarding
Selecteren

Plaatsingsmethode
 Erkalvoordig
 Meervoordig

Soort verdeling
Aantal sprinklersets: 2
Afstand [mm]: 2000

Hoogte leiding [mm]: 2963,52
Hoogte sprinklerkop [mm]: 2600
Schiel bocht [°]: 0
Lengte [L3] [mm]: 409,52

Positie sprinkler

Teugstellen naar standaardwaarden

OK Annuleren

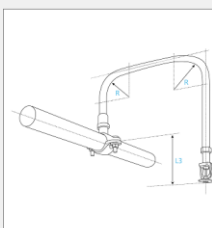



Hololens

Hydro-Unit Utility Line HU2 MCMF

EMC 3.0 Revit 0316

AFBEELDING 3D

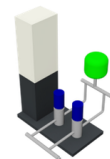

Drukverhogingsinstallatie

HU2 DPV2 /6 B MCMF 60Hz - A HU232602D64A

Artikelnummer
fabrikant HU232602D64A

Website fabrikant <http://dp.nl/nl/p/products/Hydro-Unit%20Utility%20Lir>

Laatst bijgewerkt : 19-01-2017

Bestanden ETIM-artikeldata Prijs & voorraad

	Bestandsnaam	Type	Bestandsgrootte
☑	M_Pump_Booster_MEPCoent_Duijvelaar Pompen_HU2_Frequency Driven.rfa		652 KB
☑	M_Pump_Booster_MEPCoent_Duijvelaar Pompen_HU2_Frequency Driven.txt		29.9 KB

Download

Toevoegen aan downloadlijst

One Extended Uniform Content Standard

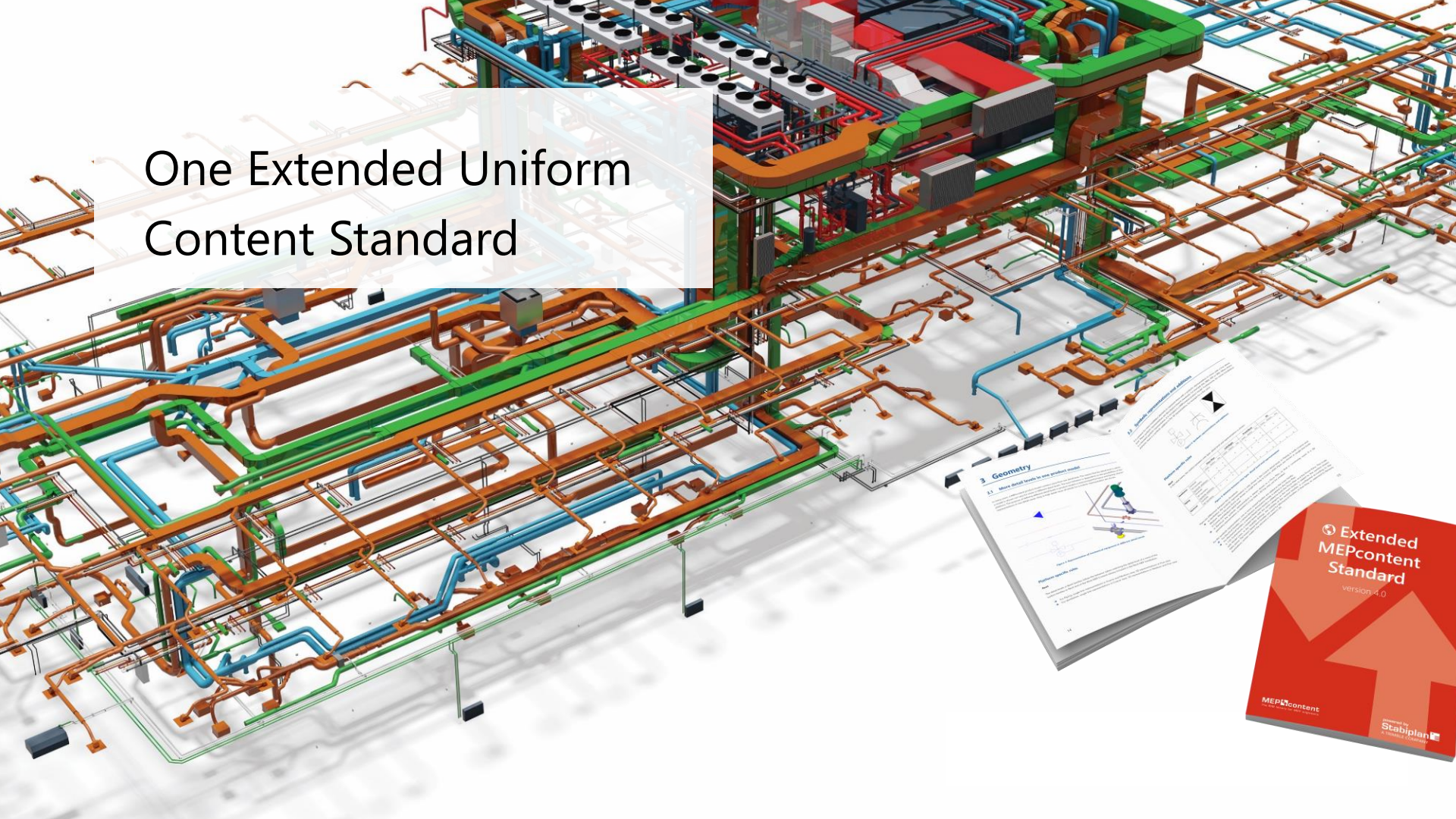

3 Geometry

3.1. Main duct levels in one parallel riser

3.1.1. Main duct levels in one parallel riser

3.1.2. Main duct levels in one parallel riser

3.1.3. Main duct levels in one parallel riser

3.1.4. Main duct levels in one parallel riser

3.1.5. Main duct levels in one parallel riser

3.1.6. Main duct levels in one parallel riser

3.1.7. Main duct levels in one parallel riser

3.1.8. Main duct levels in one parallel riser

3.1.9. Main duct levels in one parallel riser

3.1.10. Main duct levels in one parallel riser

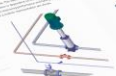

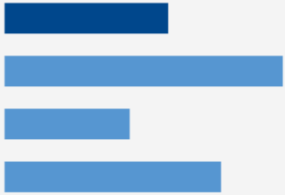

Type based families



Symbolische representaties

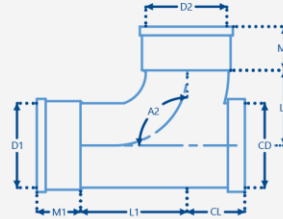

Maatschetsen

D1 L1 M1
D2 L2 M2
Height Length
Nominal Diameter

Parametrische families



Classificaties

V bar Hz
kW m³/h °C
kPa rpm L

Technische data

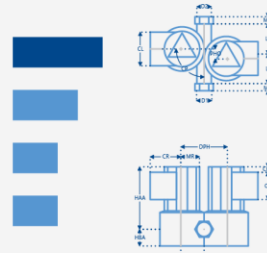

Op maat maken



EMCS

File Architecture Structure Steel Systems Insert Annotate Analyze Massing & Site Collaborate View Manage Add-Ins StabTOOLS Stabacad W-installatietechniek Stabacad E-installatietechniek Stabiplan Modify

Modify Link Revit Link IFC Link CAD Link Topography DWF Markup Decal Point Cloud Coordination Model Manage Links Import CAD Import gbXML Insert from File Image Manage Images Load Family Load as Group Import Load from Library

Properties

3D View

3D View: TR 3D Edit Type

Graphics

View Scale 1:100

Scale Value 1: 100

Detail Level Fine

Parts Visibility Show Original

Detail Number 1

Rotation on... None

Visibility/Grap... Edit...

Graphic Displ... Edit...

Discipline Coordination

Show Hidden... By Discipline

Default Analy... None

Visible in Opti... all

Sub-Discipline C00_Algemeen

Sub-Disciplin...

Sun Path

Extents

Crop View

Crop Region...

Annotation Cr...

Far Clip Active

Far Clip Offset 304800.0

Scope Box None

Section Box

Camera

Rendering Set... Edit...

Locked Orient...

Projection Mo... Orthographic

Eye Elevation 1255.2

Target Elevation 1417.7

Camera Positi... Adjusting

Identity Data

View Template <None>

View Name TR 3D

Dependency Independent

Title on Sheet

Sheet Number 0

Sheet Name Sprinkler Tech...

Phasing

Phase Filter Show All

Properties help Apply

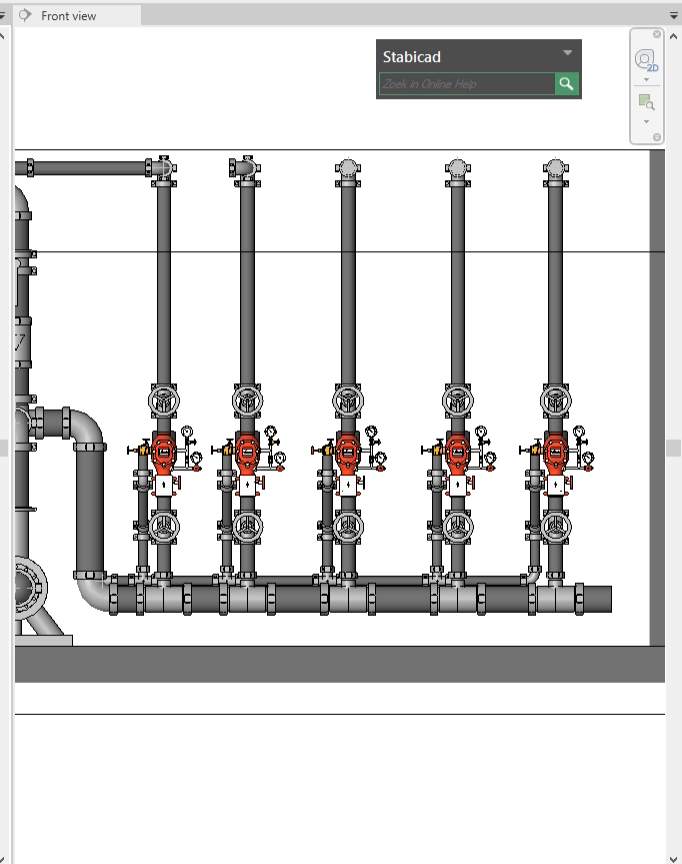
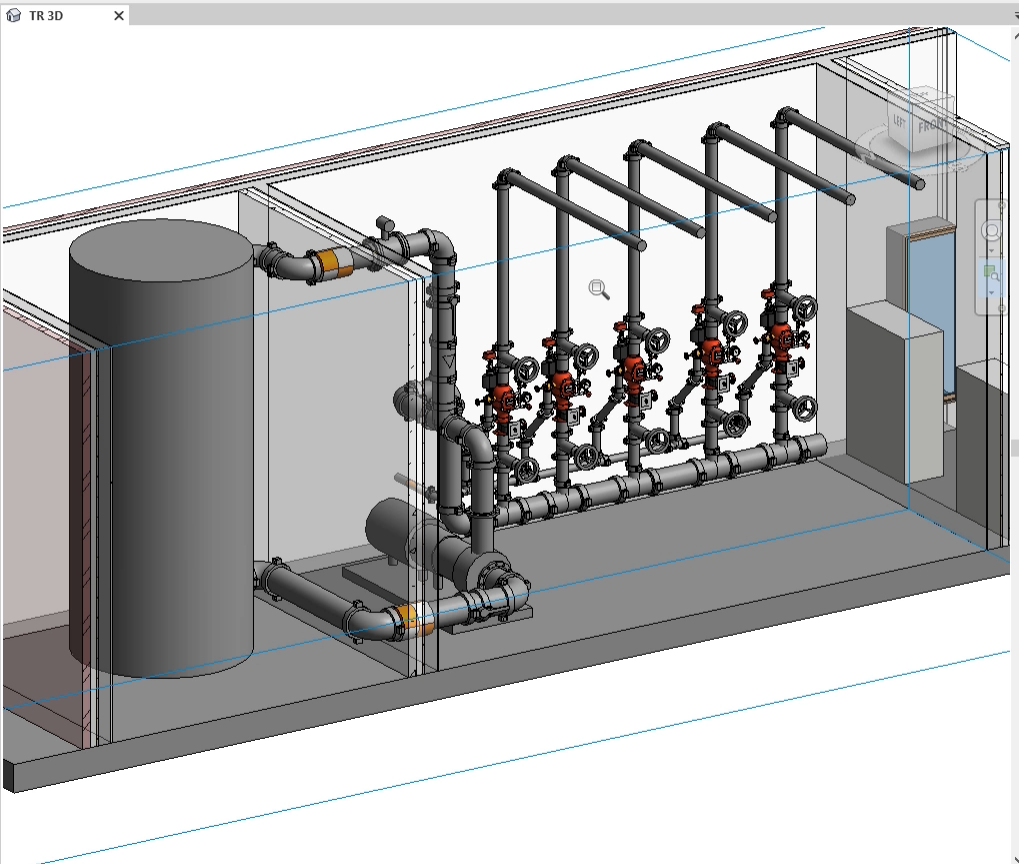

Artikelinformatie op leidingen, kanalen & kabelgoten

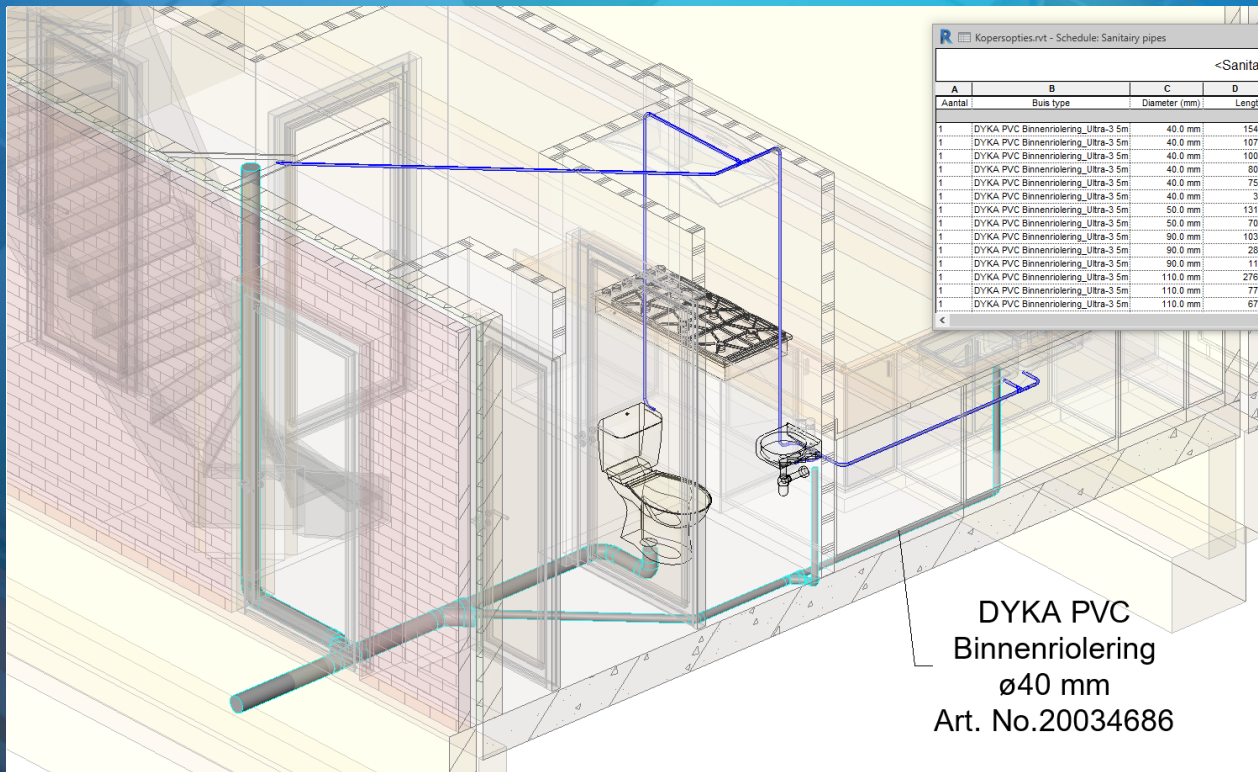

Kopersopties.rvt - Schedule: Sanitary pipes

<Sanitary pipes>

A	B	C	D	E	F	G	H
Aantal	Buis type	Diameter (mm)	Lengte	Manufacturer Art.	GTIN	ETM Article Class	GLN
1	DYKA PVC Binnenriolering_Ultra-3 5m	40.0 mm	1549	20034686	8716936022581	EC010882	8716936000008
1	DYKA PVC Binnenriolering_Ultra-3 5m	40.0 mm	1077	20034686	8716936022581	EC010882	8716936000008
1	DYKA PVC Binnenriolering_Ultra-3 5m	40.0 mm	1000	20034686	8716936022581	EC010882	8716936000008
1	DYKA PVC Binnenriolering_Ultra-3 5m	40.0 mm	801	20034686	8716936022581	EC010882	8716936000008
1	DYKA PVC Binnenriolering_Ultra-3 5m	40.0 mm	751	20034686	8716936022581	EC010882	8716936000008
1	DYKA PVC Binnenriolering_Ultra-3 5m	40.0 mm	33	20034686	8716936022581	EC010882	8716936000008
1	DYKA PVC Binnenriolering_Ultra-3 5m	50.0 mm	1314	20034688	8716936022604	EC010882	8716936000008
1	DYKA PVC Binnenriolering_Ultra-3 5m	50.0 mm	702	20034688	8716936022604	EC010882	8716936000008
1	DYKA PVC Binnenriolering_Ultra-3 5m	90.0 mm	1037	20034692	8716936022642	EC010882	8716936000008
1	DYKA PVC Binnenriolering_Ultra-3 5m	90.0 mm	284	20034692	8716936022642	EC010882	8716936000008
1	DYKA PVC Binnenriolering_Ultra-3 5m	90.0 mm	113	20034692	8716936022642	EC010882	8716936000008
1	DYKA PVC Binnenriolering_Ultra-3 5m	110.0 mm	2769	20034694	8716936022666	EC010882	8716936000008
1	DYKA PVC Binnenriolering_Ultra-3 5m	110.0 mm	773	20034694	8716936022666	EC010882	8716936000008
1	DYKA PVC Binnenriolering_Ultra-3 5m	110.0 mm	674	20034694	8716936022666	EC010882	8716936000008

DYKA PVC
Binnenriolering
ø40 mm
Art. No.20034686

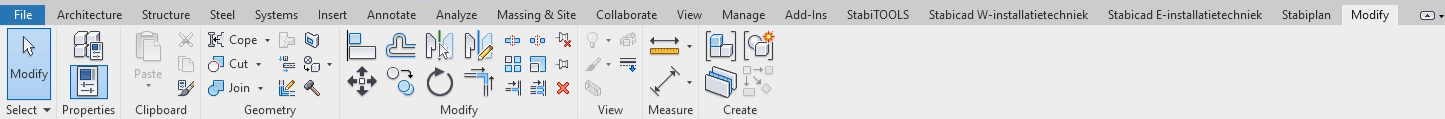

Properties

Floor Plan

Floor Plan: V00 - 1. Waterleidr

Graphics

View Scale 1 : 50

Scale Value 1: 50

Display Model Normal

Detail Level Fine

Parts Visibility Show Both

Visibility/Graphics ... Edit...

Graphic Display O... Edit...

Orientation Project North

Wall Join Display Clean all wall joins

Discipline Coordination

Show Hidden Lines By Discipline

Color Scheme Loc... Background

Color Scheme <none>

System Color Sche... Edit...

Default Analysis Di... None

Visible In Option all

Sub-Discipline Stabidac for Revit

Sub-Discipline_1 4. Buigbare leidingen

Sun Path

Underlay

Range: Base Level None

Range: Top Level Unbounded

Underlay Orientation Look down

Text

Kostprijs

Bestelfase

Extents

Crop View Crop Region Visible Annotation Crop

View Range Edit...

Associated Level V00 0-peil

Scope Box None

Column Symbolic ... 304.8

Depth Clipping Clip without line

Identity Data

View Template <None>

View Name V00 - 1. Waterleidn...

Dependency Independent

Properties help

Apply

Project Browser - Kopersopties Properties

V00 - 1. Waterleiding buigbaar

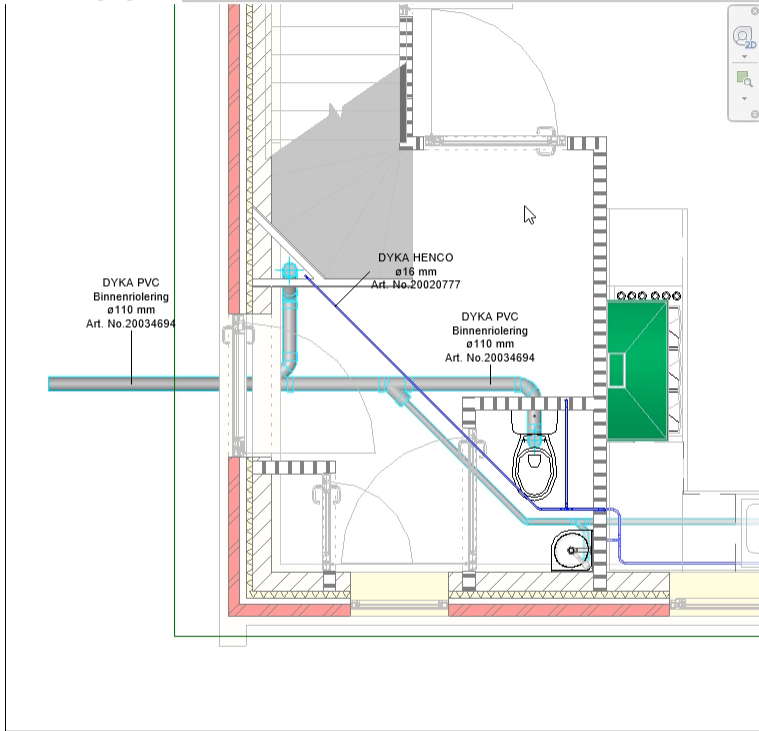

3D Buigbare leiding

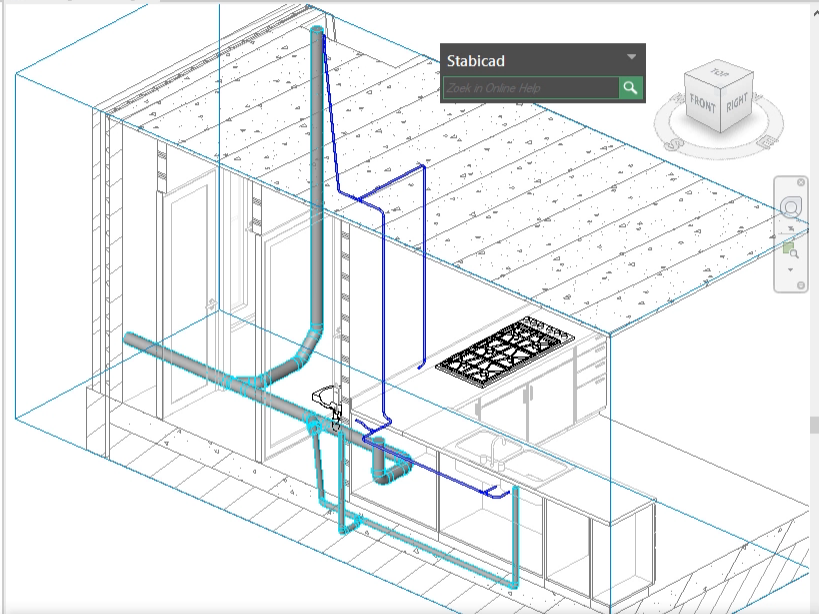

Kopersopties - Schedule: Sanitary pipes

<Sanitary pipes>							
A	B	C	D	E	F	G	H
Aantal	Buis type	Diameter (mm)	Lengte	Manufacturer Art.	GTIN	ETM Article Class	GLN
1	DYKA PVC Binnenroering_Ultra-3 5m	50.0 mm	1733	20034688	8718936022604	EC010882	8718936000008
1	DYKA PVC Binnenroering_Ultra-3 5m	50.0 mm	1338	20034688	8718936022604	EC010882	8718936000008
2	DYKA PVC Binnenroering_Ultra-3 5m	50.0 mm	1892	20034688	8718936022604	EC010882	8718936000008
1	DYKA PVC Binnenroering_Ultra-3 5m	50.0 mm	373	20034688	8718936022604	EC010882	8718936000008
1	DYKA PVC Binnenroering_Ultra-3 5m	50.0 mm	167	20034688	8718936022604	EC010882	8718936000008
1	DYKA PVC Binnenroering_Ultra-3 5m	110.0 mm	2953	20034694	8718936022666	EC010882	8718936000008
1	DYKA PVC Binnenroering_Ultra-3 5m	110.0 mm	1707	20034694	8718936022666	EC010882	8718936000008
1	DYKA PVC Binnenroering_Ultra-3 5m	110.0 mm	897	20034694	8718936022666	EC010882	8718936000008



Met Stabicad for Revit
kunnen we perfect tekenen
en rekenen volgens de
huidige normen.”

Tom Smets
zaakvoerder T-O-M



Tapwater berekening



~~Beta~~

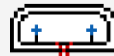

Circulatiesysteem inregelen

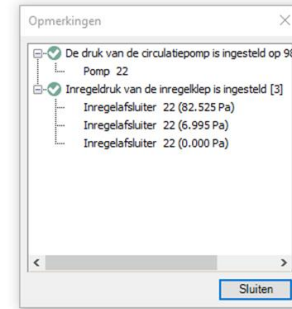
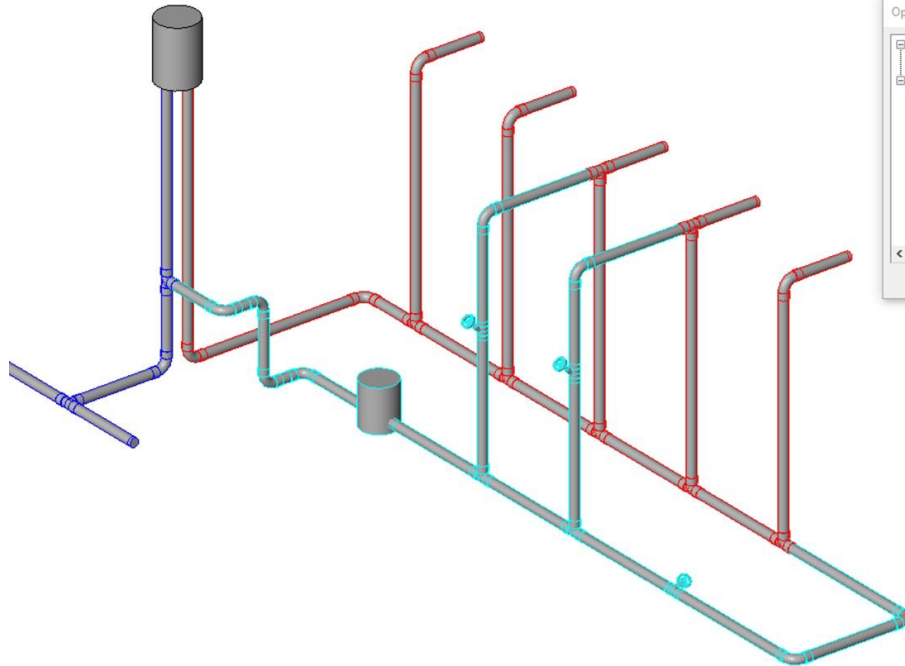

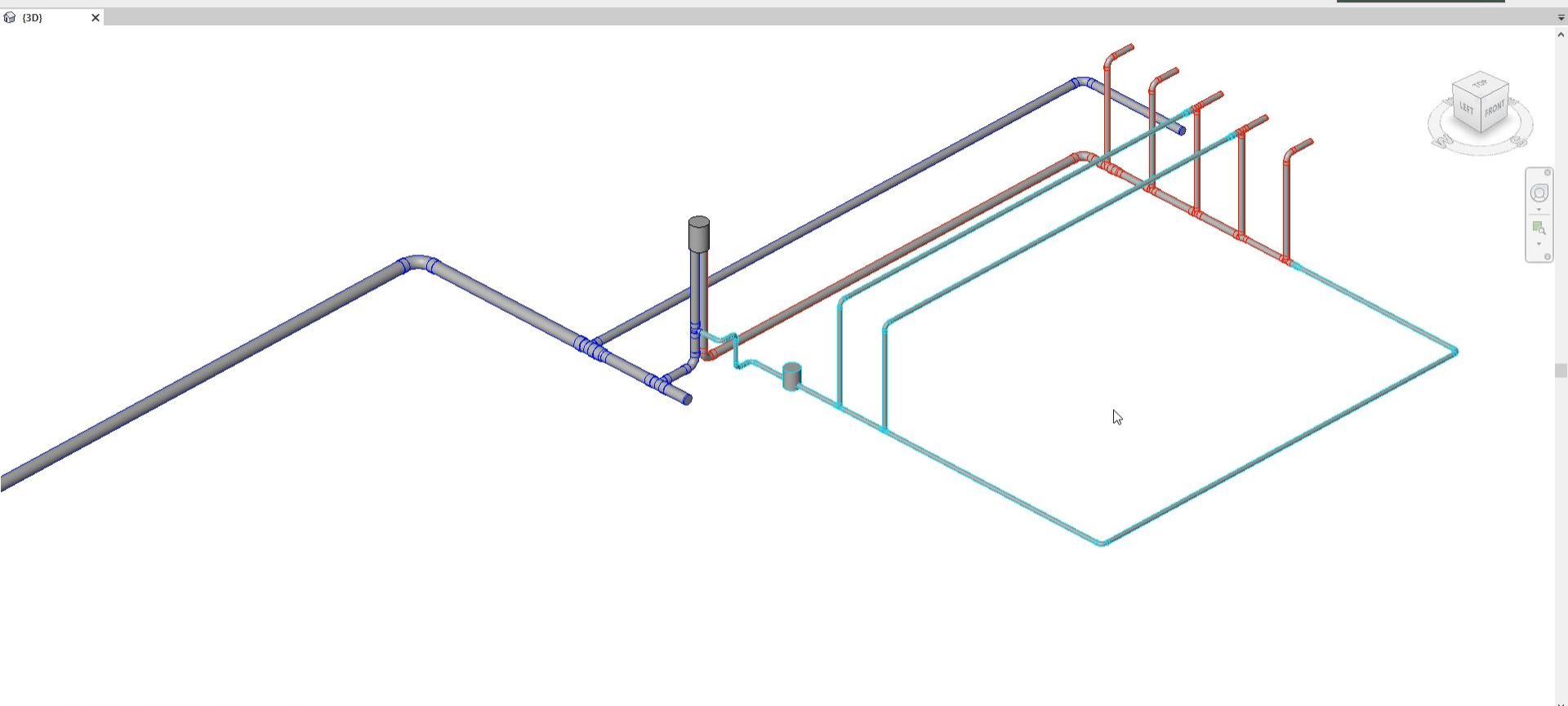

Knooppuntoplosser verbeteringen

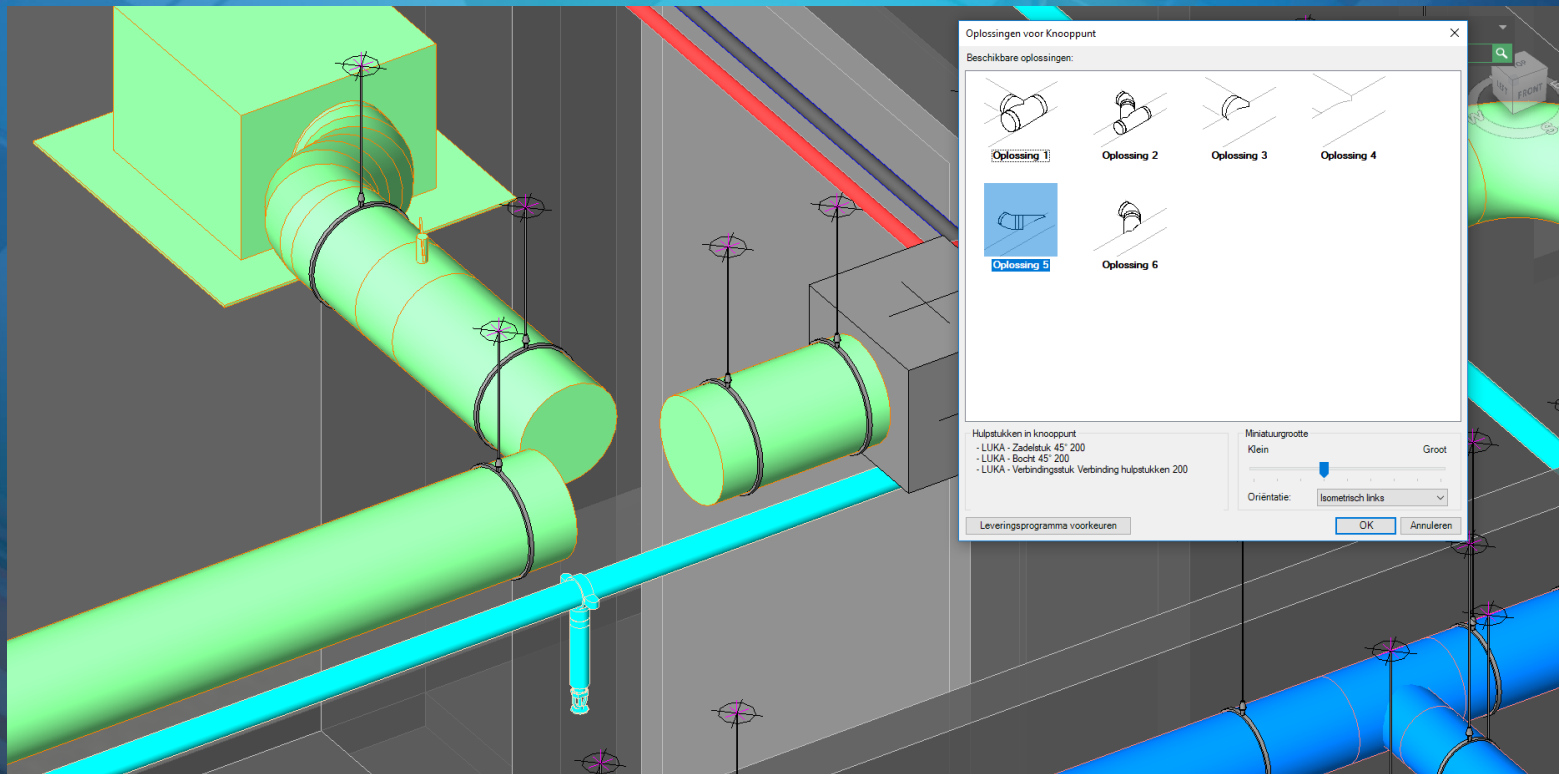

Knooppuntoplosser verbeteringen

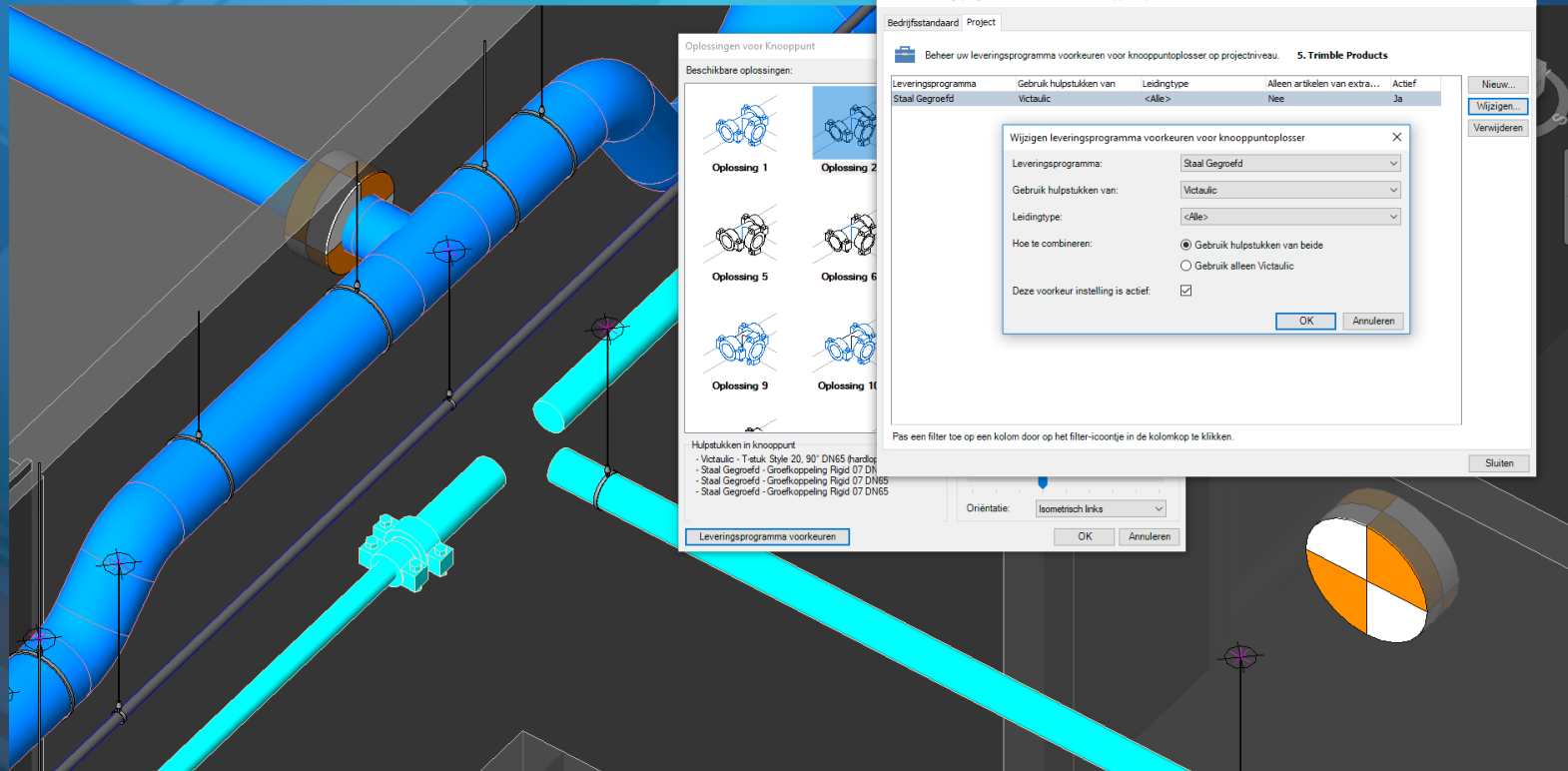

File Architecture Structure Steel Systems Insert Annotate Analyze Massing & Site Collaborate View Manage Add-Ins Trimble® Field Points MEPcontent Stabiplan StabiTOOLS StabicaD W-installatietechniek StabicaD E-installatietechniek Modify

Select Properties Clipboard Geometry Modify View Measure Create

Properties 2. Technische Ruimte 1_M

Drafting View Detail

Drafting View: 1_M Edit Type

Graphics	
View Scale	1:1
Scale Value 1:	1
Detail Level	Fine
Visibility/Graphics Overrides	Edit...
Discipline	Mechanical
Sub-Discipline	W50_W-Schema
Sub-Discipline_1	1. W-schema
Visual Style	Hidden Line
Identity Data	
View Template	<None>
View Name	1_M
Dependency	Independent
Title on Sheet	
Referencing Sheet	
Referencing Detail	

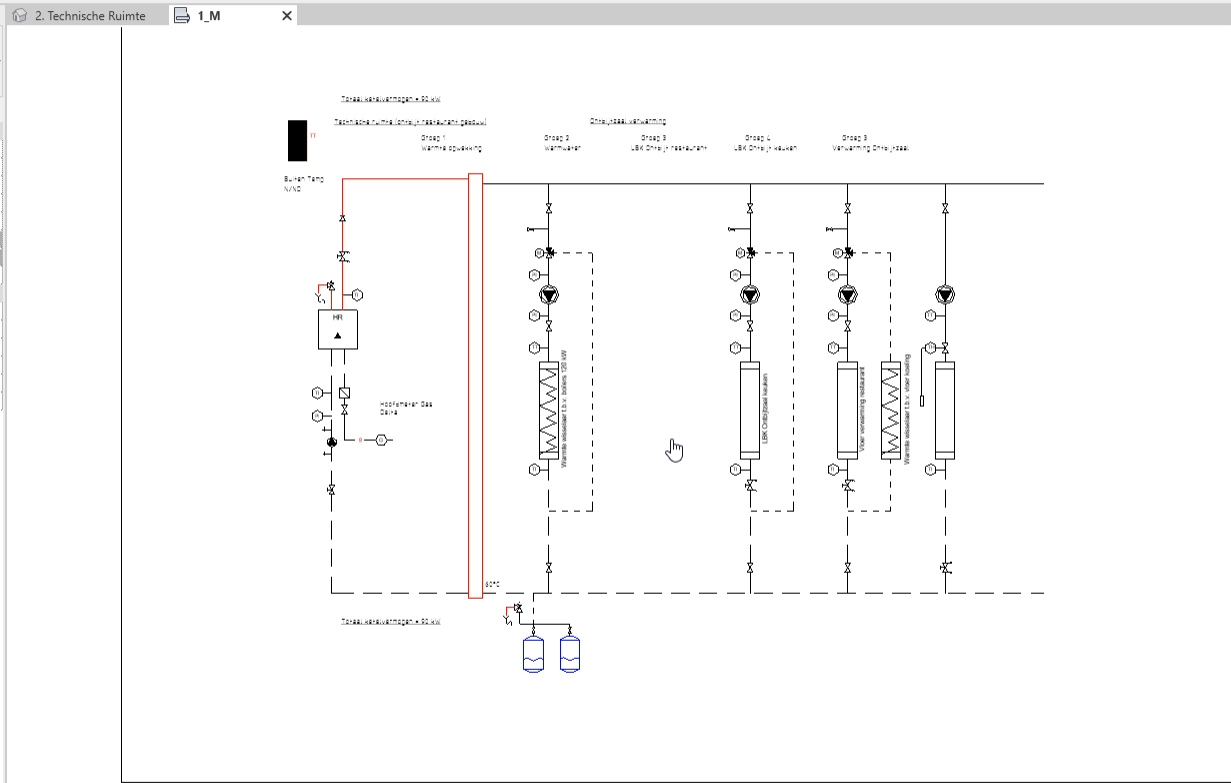

StabicaD

Look in Online Help

Ventilatie tekenvoorkeuren

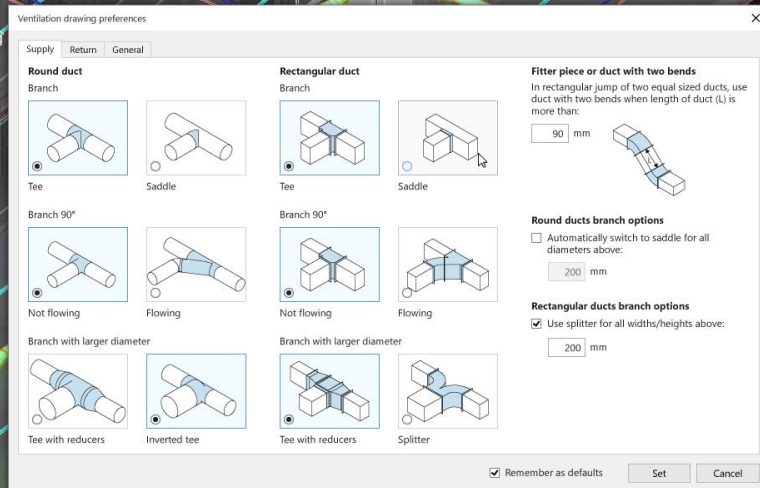
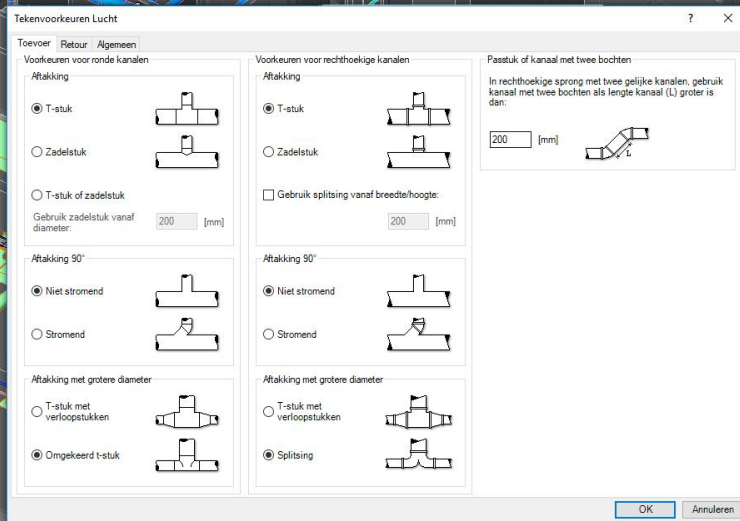

Ophangbeugels workflow



MEP Engineer



Hanger design tools



Trimble field points



Trimble field link



Trimble total station

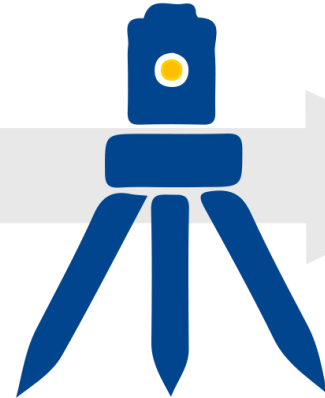



Stabicad bundel



S4R + S4A



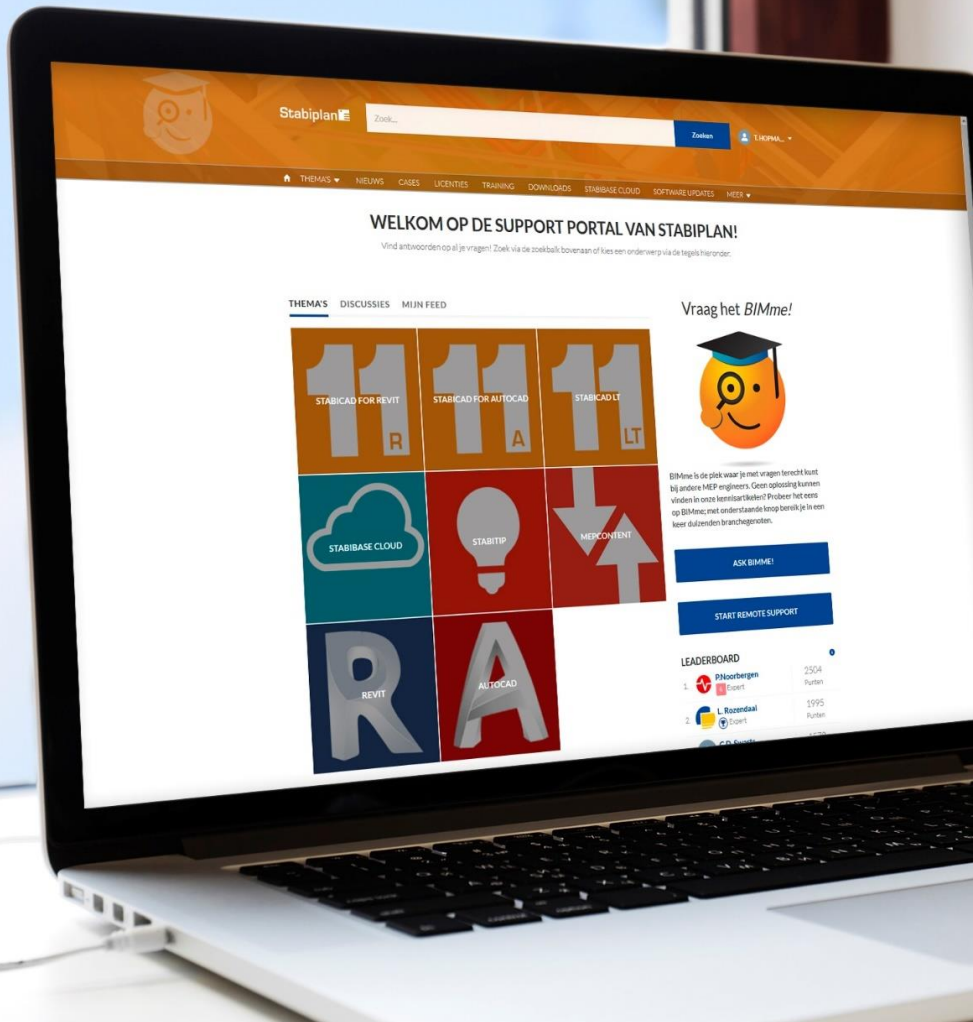

BIMme

De community voor MEP engineers

CONNECTOR IN FAMILY PLAATSEN
Discover other articles and discussions about this topic.

Connector in Family plaatsen
Dit artikel laat zien hoe u een connector in een family kunt verplaatsen.

9 8 mei 2017 - FAQ

OMSCHRIJVING
Probleem:
Ik wil meerdere connectors op een vlak tekenen maar de connector blijft vast staan op de reference lines.

Oplossing:
1. Kies tijdens het plaatsen van de connector voor Workplane in plaats van Face (Ribbon + Placement).

TRENDING ARTICLES
Aanmaken onderdelen in Revit
Zichtbaarheid in Revit
'Voorgeader' families in de StabiCAD for Revit template
Hoe te werken met urefs?
Bevingen Revit View instellingen

RELATED ARTICLES
Type Catalog gebruiken in Revit 63
PLS Veldcode Fire Protection 64
Beelden op de Revit van der zijn niet uit te halen in StabiCAD 70
Plaatsen family op ceiling licht niet 58
Aanmaken standaard template in Revit 111

Work Plane
Current Work Plane:
Name:
OK Cancel Help

Specify a new Work Plane:
 Same Level:
 Pick a plane
Pick a plane and set the work plane. It was disabled.

3. Gebruik de functie Move om de connector te verplaatsen.



Training center

Leren waar en wanneer
het u uitkomt



Zij zijn BIM LIVE!

Een greep uit onze 10.000 gebruikers

abt

RET
engineering

AEW

A

BELTHERM
LICHT- en WARMTE-TECHNIEK

studiebureau boydens
techniek en ontwerp

EEG
VAN BRACEKEL

Cegelec
Solutions & Services

CERATEC

ENGIE

INGENIEURSBUREAU
SVELT ARCHITECTURE

Hooyberghs
Bouw | Techniek | Interacties

Imtech
Belgium

istema
INGENIEURSBUREAU

Pacquet

SPiE

Stokjes
luchtbehandeling &
ventilatie-techniek

STRONG
GROW

SWECO

TALBOOM
group

THOMAS
MORE

rZ
tienem
Iga omhaal in de natuur
heeft hart samen van

TRACTEBEL
ENGIE

VAN DEN BRIELE

An architectural rendering of a modern, multi-story brick residential building. The building features a textured brick facade and numerous windows, some with balconies. In the foreground, a landscaped courtyard with various plants and trees is shown. People are depicted walking, a man is pushing a stroller, and a woman is walking a dog, suggesting a vibrant community. The sky is clear and blue.

“ We zijn overgestapt naar Stabicad for Revit. In onze grootschalige projecten zijn Revit en 3D geen overbodige luxe.”

Tim Claes
zaakvoerder Future
Clima



“ Dankzij BIM en Stabicad for Revit is het mogelijk om clashvrij te ontwerpen.



Raf Vliegen
Zaakvoerder Vliegen





Stabicad is voor ons een belangrijk tijdbesparend hulpmiddel."



Natasja Alders
Ing. Ventiline





Stabicad





KWARTAALACTIES

Kwartaalacties lente 2019

Vanaf vandaag tot en met juni 2019 heeft Stabiplan weer kwartaalacties:

- Aankoop of Desktop Subscription [Stabicad Bundle](#) Electrical of Mechanical (of upgrade) + gratis [Excel app](#) óf [Openings app](#) 1 jaar
- Aankoop of Desktop Subscription [Stabicad Bundle](#) Electrical of Mechanical (of upgrade) + gratis halve dag [Consultancy](#)
- Aankoop of Desktop Subscription [Stabicad Bundle](#) Electrical of Mechanical (of upgrade) + gratis [Trimble Connect](#) 3 licenties 1 jaar
- Aankoop of Desktop Subscription [Stabicad LT](#) + gratis [Trimble Connect](#) 2 licenties 1 jaar

Deze acties zijn geldig vanaf 21 maart 2019 tot en met 30 juni 2019 en zijn niet geldig in combinatie met andere acties. Neem contact met ons op voor meer informatie en actievoorwaarden.

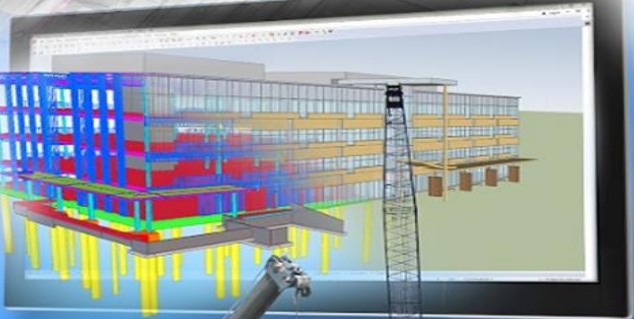
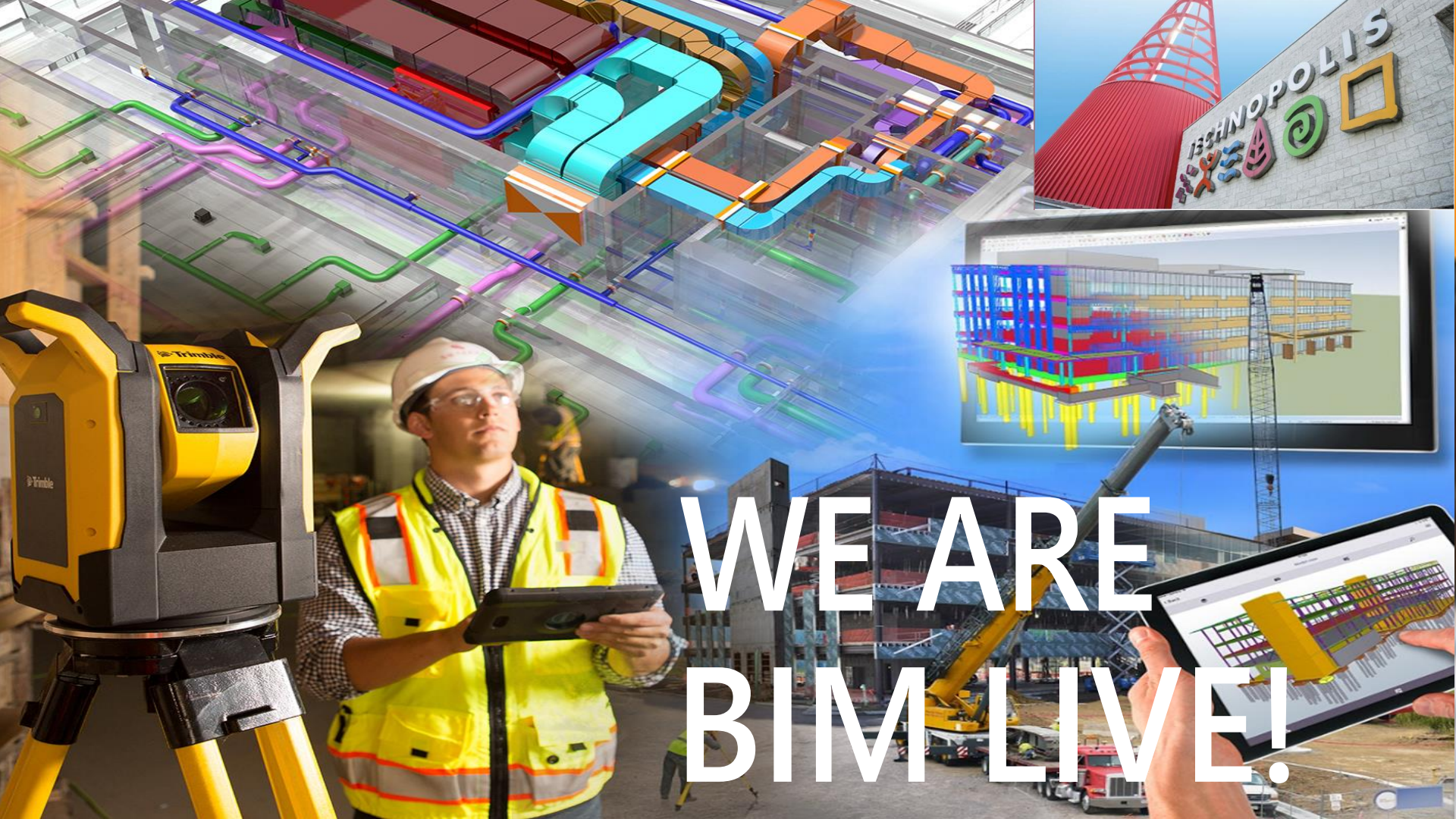

WE ARE
BIM LIVE!



Demo Stabicad 11

- Nieuwe functies Stabicad11/12
- Eendraadschema in Revit
- Sparingen workflow
- Nieuwe Knoopuntoplosser
- Berekeningen in Revit
- Prefab
- Schema-W
- Cloud/Trimble Connect

